

# Black Bruin



**Operation manual  
CTR201 control system**

# Contents

<b>1</b>	<b>General instructions.....</b>	<b>3</b>
1.1	About the manual.....	3
1.2	Intended use.....	3
1.3	Warranty.....	3
1.4	Product identification.....	3
1.5	Revision comments.....	4
<b>2</b>	<b>Safety instructions.....</b>	<b>5</b>
2.1	Warning symbols.....	5
<b>3</b>	<b>Product description.....</b>	<b>6</b>
3.1	Working principle.....	6
3.2	Driving mode.....	6
3.3	HDC function (Hill descent control) (option).....	7
3.4	Freewheeling mode.....	7
<b>4</b>	<b>Getting started.....</b>	<b>8</b>
4.1	Display and user interface.....	8
4.2	Power-up the control system.....	8
4.3	Menu.....	10
<b>5</b>	<b>Main view elements.....</b>	<b>14</b>
5.1	Main view at the initial state.....	14
5.2	Status bar - Alarms and warnings.....	15
5.3	Tractive power and HDC level indication.....	16
5.4	Operating mode indication.....	17
<b>6</b>	<b>Operating functions.....</b>	<b>19</b>
6.1	Drive control modes.....	19
6.2	Tractive power level selection.....	20
6.3	Driving and freewheeling functions in the automatic drive-control mode.....	21
6.4	Driving and freewheeling functions in the manual drive-control mode.....	23
6.5	Braking in driving mode.....	25
6.6	Assisting traction control (ATC).....	27
6.7	Auxiliary valve control (AUX), (F1) (option).....	30
6.8	Keypad lock.....	30
<b>7</b>	<b>Setup.....</b>	<b>32</b>
7.1	User parameters.....	32
7.2	Automatic freewheeling conditions.....	35
7.3	Setting the values for the automatic freewheeling.....	36
<b>8</b>	<b>Troubleshooting.....</b>	<b>38</b>
8.1	Display status indicator LED.....	41
8.2	Control device segment-display.....	41

# 1 General instructions

## 1.1 About the manual

This manual contains the instructions for the operation of Black Bruin CTR201 control system. Obey these instructions when you use the product.

Black Bruin CTR201 control system is part of the On-Demand Drive System transmission solution. The On-Demand Drive System product manual describes the design and installation instructions of the transmission solution.

All information is based on information that was available at the time that this manual was written. The manufacturer reserves the right to change the content of this manual without further notice.

Please visit [www.blackbruin.com](http://www.blackbruin.com) for the most recent version of this manual. The product datasheets and the 3D-models are available from the manufacturer by request.

**Note:**

If there are differences between the English text and its translation, the English text is always the most accurate. This document is written in Simplified Technical English (ASD-STE100).

## 1.2 Intended use

Black Bruin On-Demand Drive System is a transmission solution for tractor-driven trailers and working equipment.

On-Demand Drive System is very applicable for equipment that periodically requires additional power and is towed without hydraulics.

On-Demand Drive System is designed for off-road driving and it must be powered off when you drive in road traffic.

Black Bruin CTR201 control system is only applicable to use together with the freewheeling Black Bruin motors.

## 1.3 Warranty

Check the package and the product for transport damage when receiving goods. The package is not meant for long term storage; protect the product appropriately.

Do not dismantle the product. The warranty is void if the product has been disassembled.

The manufacturer is not responsible for damages resulting from misinterpreted, non-compliance, incorrect, or improper use of the product that goes against the instructions given in this document.

## 1.4 Product identification

The product has an identification plate. The identification plate has the information that follows:

## General instructions

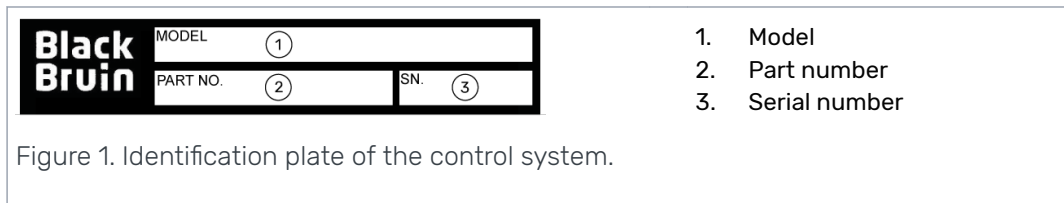

## 1.5

### Revision comments

22.09.2020 (Software version 03.02.00) - This manual is published.

## 2 Safety instructions

The instructions that follow apply to all procedures related to the product. Read these instructions fully and follow them carefully.

- Use necessary personal protective equipment when you do work with the product.
- Use correct support with the product. Make sure that the product cannot accidentally fall or turn.
- Use only appropriate equipment and attachments when you lift and move the product.
- Make sure that it is not possible to pressurize the hydraulic lines during product installation and maintenance procedures.
- During the operation the product temperature can be over 60 °C (140 °F). Hot surfaces can burn you. Be careful of hot hydraulic fluid when you disconnect the hydraulic connections.

### 2.1 Warning symbols

The following symbols are used in this manual:



**Note:**

Useful information.



**Danger:**

Danger of death or injury.



**Attention:**

May cause damage to the product.

## 3 Product description

### 3.1 Working principle

The Black Bruin On-Demand Drive System can use hydraulic motors in the operating modes that follow:

- Driving mode
  - Driving mode with HDC function (Hill descent control) (option)
- Freewheeling mode.

The chapters that follow give the working principles of these modes.

### 3.2 Driving mode

In this mode the motors help the vehicle to move in the direction of travel. You can adjust the tractive power level to the driving conditions. The power level stays constant also if the speed changes. When the tractor brakes the system reduces the working pressure to the minimum level and the hydraulic motors do not have tractive power.

2-speed hydraulic motors give wider speed range for the hydraulic drive.

If the vehicle wheels slip, the assisting traction control ATC increases the torque on the wheels that have more traction.

Typical situations to operate in the driving mode are:

- Driving up steep slopes



- Moving rearward on steep slopes



- Going across obstacles



- Driving on slippery or soft surfaces.



### 3.3 HDC function (Hill descent control) (option)

The HDC function helps when you drive the vehicle down on steep slopes, in both forward and reverse driving modes.

When the HDC function is active, the wheel motors resist the wheel movement to the driving direction. You can adjust the HDC power level during the operation.

Typical situations for the use of the HDC function are:

- Driving down steep slopes  
HDC function off, vehicle accelerates.



- Driving down steep slopes  
HDC function on, function helps the vehicle to maintain the speed.



- Moving rearward on steep slopes  
HDC function off, vehicle accelerates.



- Moving rearward on steep slopes  
HDC function on, function helps the vehicle to maintain the speed.



### 3.4 Freewheeling mode

In the freewheeling mode you can freewheel the motors without energy loss or overheating problems (stationary cylinder block - no centrifugal forces), even at high speeds. You can engage the drive again during movement when the speed is in the working range.

If the pressure level is not sufficient due to increased driving speed, the control system automatically switches to freewheeling. This protects the motor from overloading.

The operator can also manually change the mode to freewheeling.

Typical situations to operate in the freewheeling mode are:

- **When you drive on road**
- When you do work above the maximum working speed range
- When the working conditions are easy.

## 4 Getting started

### 4.1 Display and user interface

The display operates as a control element for the drive system. It also shows information to the user about the operation of the system.

The functions of the **F1 - F4** buttons change together with the view and the mode. The icons that show at the bottom of the display refer to the related functions of the **F1 - F4** buttons.

The background color of the icon shows if the mode of the function is **ON** or **OFF**. In the figure below the function **AUX** for button **F1** is **ON**. The background color of the icon is grey.

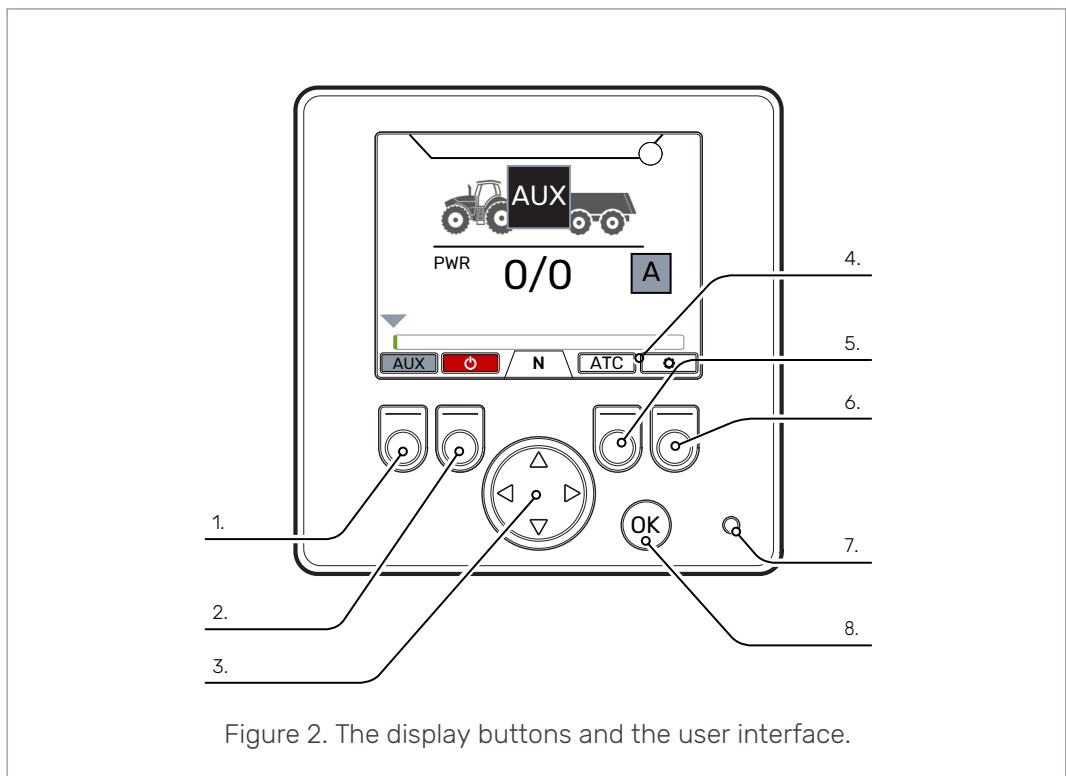

Figure 2. The display buttons and the user interface.

1	<b>F1</b>	2	<b>F2</b>
3	Selection arrows (left, right) Selection arrows (up, down)	4	Function icons for <b>F1 - F4</b> buttons
5	<b>F3</b>	6	<b>F4</b>
7	Status indicator light	8	<b>OK</b>

### 4.2 Power-up the control system

After the control system power-up, the start-up view comes on and the program version shows on the display.



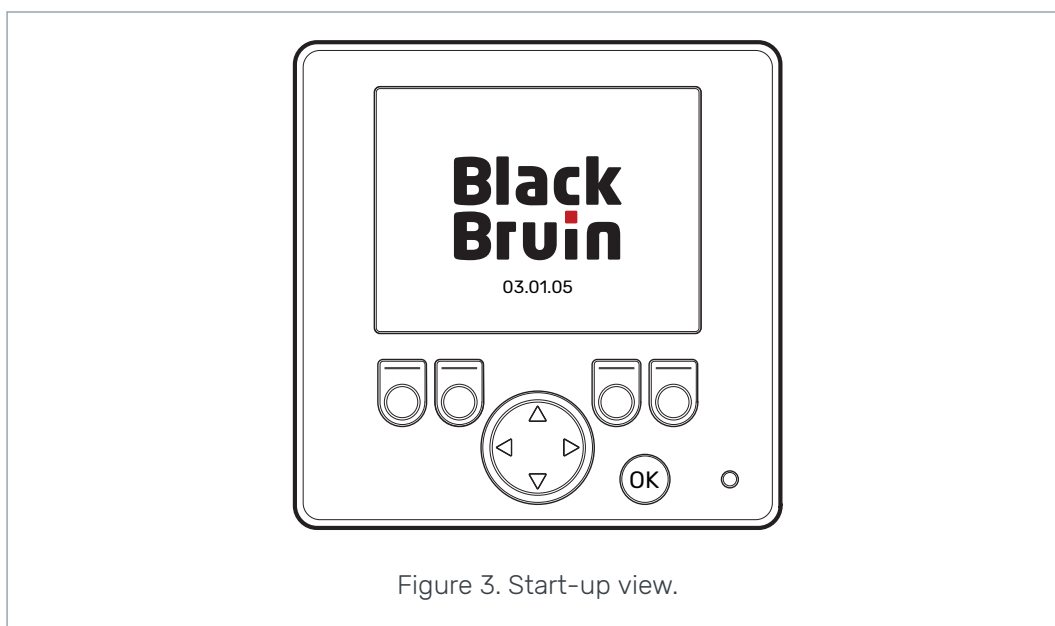

The brake-signal check-dialog view shows on the display.

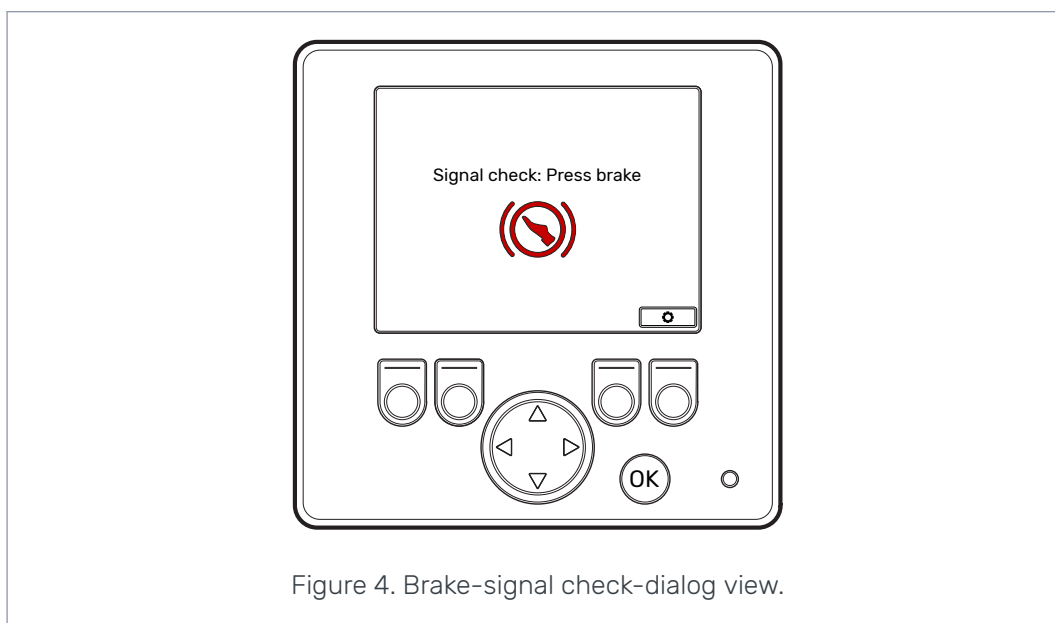

Operating functions and the main view are not available until you press the brake and the system detects the brake signal. But you can open the main menu from the brake-signal check-dialog view.

When you use the control system for the first time, do a preliminary check of the settings before you use the operating functions. It is very important that you adjust the maximum pressure level first.

You can also open the main menu from the main view. To open the main menu, push the F4 (☒) button.

To continue to the main view, press the brake.

If the brake-signal check-dialog view does not go out of view when you press the brake, see chapter [Troubleshooting](#) on page 38.

The brake-signal check-dialog view shows after each power-up, after which the system is in the freewheeling (N) mode.

## 4.3 Menu

### 1. Main menu

To open the main menu from the main view, push the F4 button (⚙).



**Note:**

The main menu is available only when the system is in the free-wheeling mode.

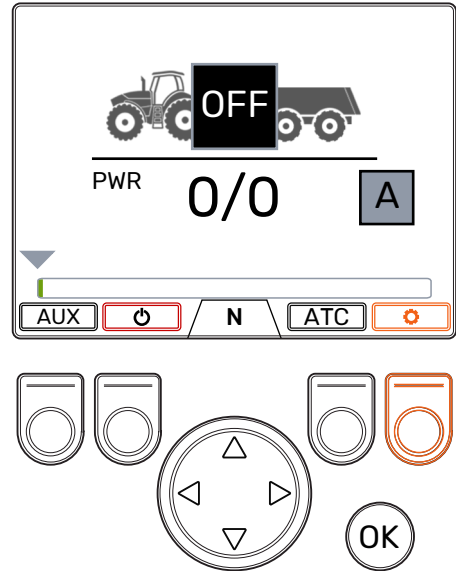

### 2. Language and display brightness

You can adjust the display brightness and change the control system language from the main menu.

You can change between the automatic and manual drive-control modes with the manual mode setting.

If the ISOBUS connection is not available, the setting is not visible and the manual mode is always on.

- Arrow buttons up/down: Select the value you want to adjust.
- Arrow buttons left/right: Adjust the values.

The selection of language has an effect on the language of the user interface and the parameter names.

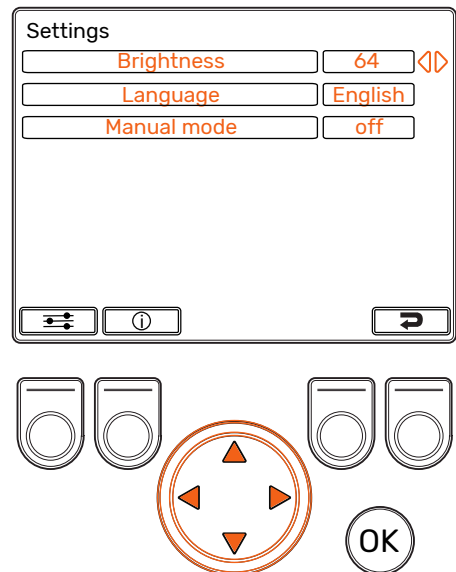

### 3. Parameters and system information menus

Parameters menu shows the settings related to the operation of the system. You can adjust these settings.

Information menu shows the information about the system and operations, for example the operating hours and the latest fault messages.

- In the main menu push the F1 button to go to the user parameters menu.
- In the main menu push the F2 button to go to the system information menu.
- Push the F4 button to exit the main menu.

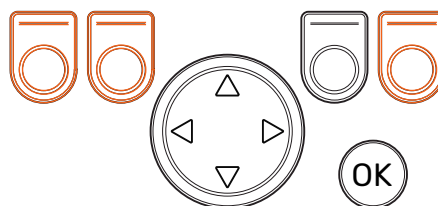
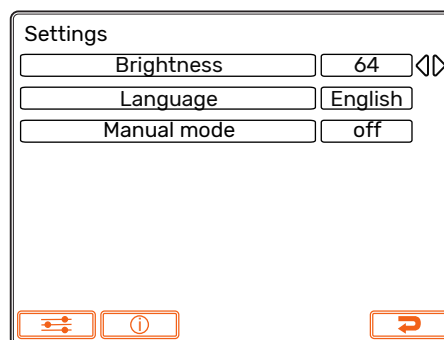

### 4. Parameter selections

Parameter names are in the same language as the user interface. See chapter [User parameters](#) on page 32 for the detailed information on the parameters and their possible values.

- Arrow buttons up/down: Select the parameter you want to adjust.
- Arrow buttons left/right: Adjust the parameter values.

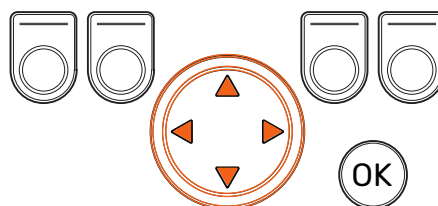
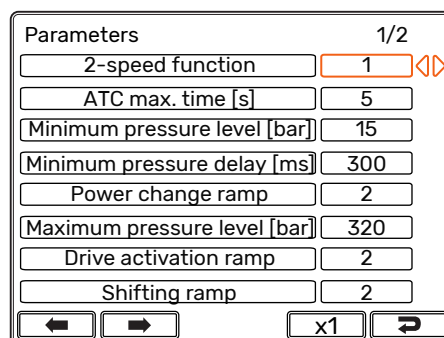

### 5. Parameter selections, page scrolling

If the system has many options, the parameter list can be more than one page long. You can see the page number and the total number of pages at the top right corner of the display. Push the buttons F1 and F2 to scroll the pages.

- Previous page: F1
- Next page: F2

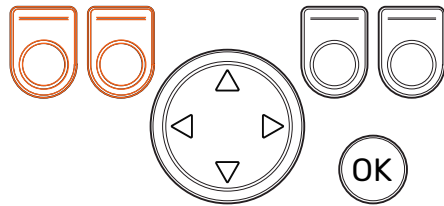
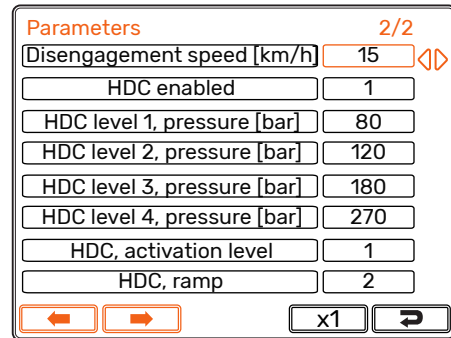

### 6. Parameter multiplier

The multiplier shows the step value in which you can change the parameter value. You can change the step value when you have to adjust large values. The multiplier values are x1, x10, x100 and x1000.

- Push the F3 button to change the multiplier value. The icon above the button shows the selected multiplier value.
- Push the F4 button to exit the parameter menu.

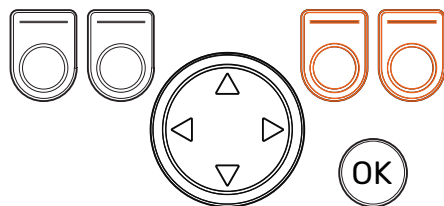
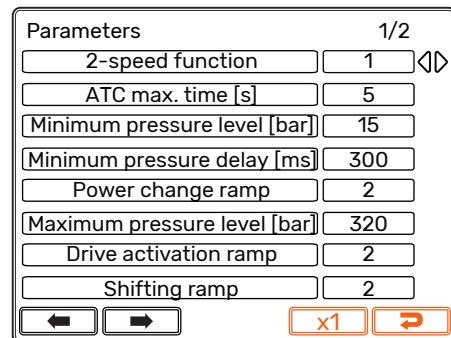

## 7. System information

In the main menu push the F2 button to go to the system information menu.

Information menu shows the information about the system and operations.

This information is necessary for example for troubleshooting and support requests.

- Model series: Control system model: CTR201
- Sw Version: Software version numbers are as follows:
  1. Control device software version
  2. Display software version
  3. 4WD-auxiliary device software version (only in 4WD systems).
- Last error: Latest error message. See chapter [Troubleshooting](#) on page 38 for the list of alarm codes.
- Safestate occurred: How many times the system has been to the safe state.
- Working hours: System operating hours (the display has been on).
- Forward: The number of times the system has been in the forward driving mode.
- Backward: The number of times the system has been in the reverse driving mode.
- TOW: The number of times the system has been in the freewheeling mode.
- Push and hold the F2 and F3 buttons at the same time to reset the counters.
- Push the F4 button to exit the information menu.

Model series	CTR201		
Sw Version	03.01.05	03.01.05	03.01.05
Last error	Coil_failure_PDB		
Safestate occurred	1		
Working hours	41		
Forward	18		
Backward	3		
TOW	18		

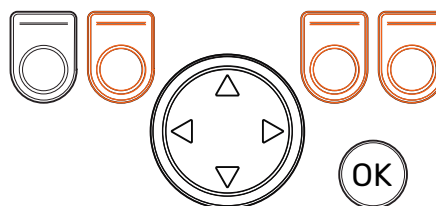

## 5 Main view elements

### 5.1 Main view at the initial state

You can manage the operating functions from the main view.

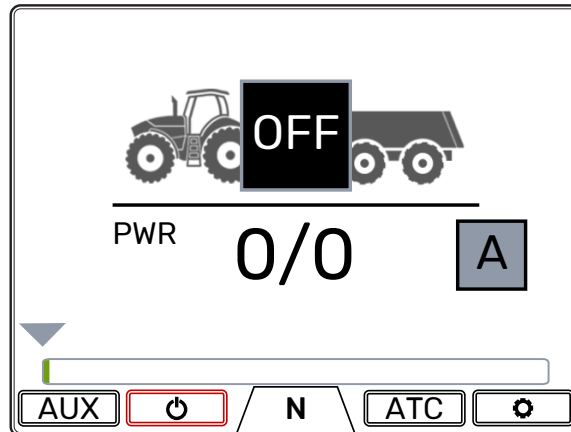

Figure 5. The main view after the power-up. The automatic drive-control mode is in the OFF state. The system is in the freewheeling mode. If the system does not have the auxiliary valve control, the AUX icon does not show.

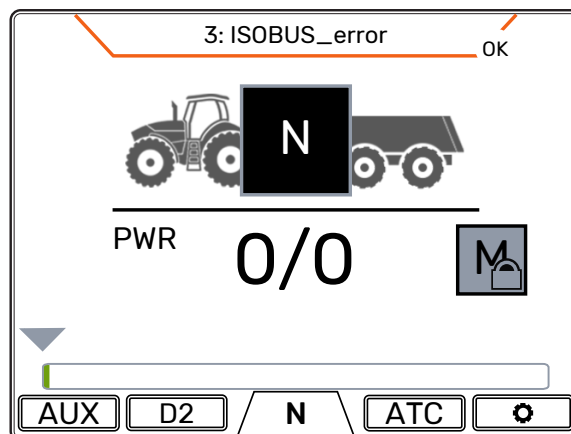

Figure 6. The main view after the power-up when the system does not detect the ISO-BUS connection. The system starts up in the manual drive-control mode. If the system has the 2-speed motors, the D2 icon shows.

**Note:**

The trailer icon can be different from the one in the figure.

## 5.2 Status bar - Alarms and warnings

The status bar at the top of the main view shows all alarms and warnings.

The background color of the status bar is:

- Black for the alarms
- Grey for the warnings.

Red background color of the OK icon at the top of the main view means that you must reset the alarm before you can activate the drive. If you have removed the cause for the alarm, push the *OK* button to reset the alarm. See chapter [Troubleshooting](#) on page 38 for more detailed information on the alarms.

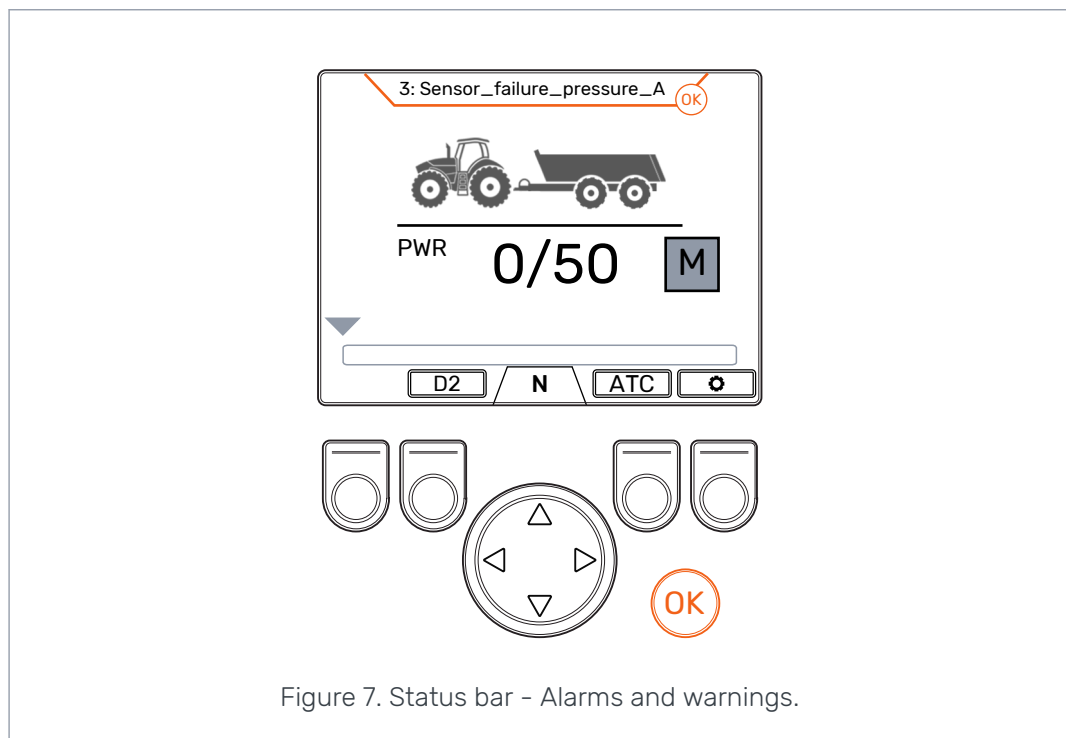

Figure 7. Status bar - Alarms and warnings.

### 5.3 Tractive power and HDC level indication

Tractive power level is shown on a scale of 0 – 100%. Full power level is related to the maximum pressure level specified in the parameters.

If the system has the HDC function (Hill descent control), the HDC level is also related to the maximum pressure level specified in the parameters.

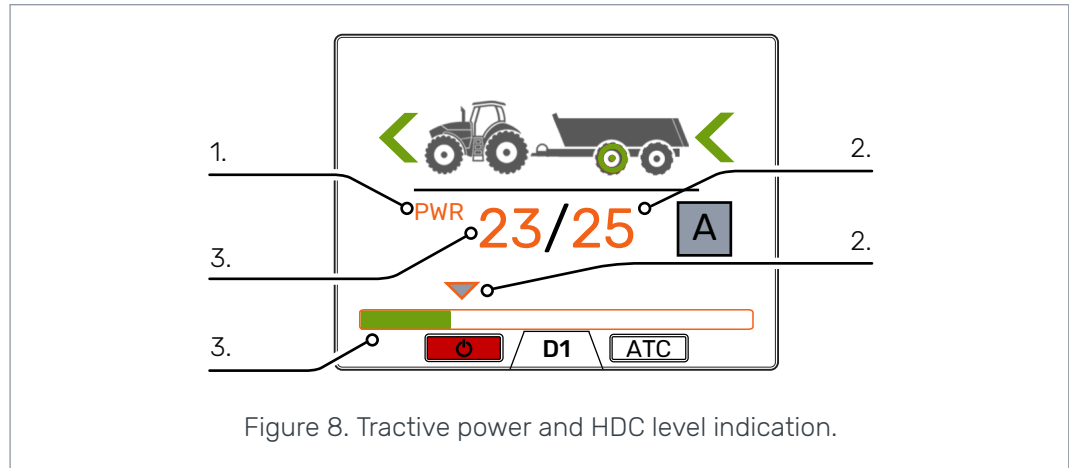

Figure 8. Tractive power and HDC level indication.

<p>1 <b>Mode: PWR/HDC</b></p> <p>Shows the active mode on the display:</p> <ul style="list-style-type: none"> <li>• <i>PWR</i>: Tractive power adjustment. The values on the display show the tractive power level.</li> <li>• <i>HDC</i>: Hill descent control adjustment (only in systems that have the HDC function). The values on the display show the HDC function intensity.</li> </ul>	<p>2 <b>Selected level:</b></p> <ul style="list-style-type: none"> <li>• The number shows the set value.</li> <li>• The grey arrow above the colored power bar shows the set value.</li> </ul>
<p>3 <b>Measured level:</b></p> <ul style="list-style-type: none"> <li>• The number shows the measured value</li> <li>• The colored power bar below the numbers shows the measured value: <ul style="list-style-type: none"> <li>• Green: <i>PWR</i></li> <li>• Red: <i>HDC</i>.</li> </ul> </li> </ul>	

Measured and set values are percentages from the maximum pressure level that is specified in the settings (Maximum pressure level [bar]).

For example, with the numbers shown in the figure, the calculation for 200 bar system gives the pressure levels as follows:

- Selected level 25% => 200 bar x 25/100 = 50 bar
- Measured level 23% => 200 bar x 23/100 = 46 bar.



## 5.4 Operating mode indication

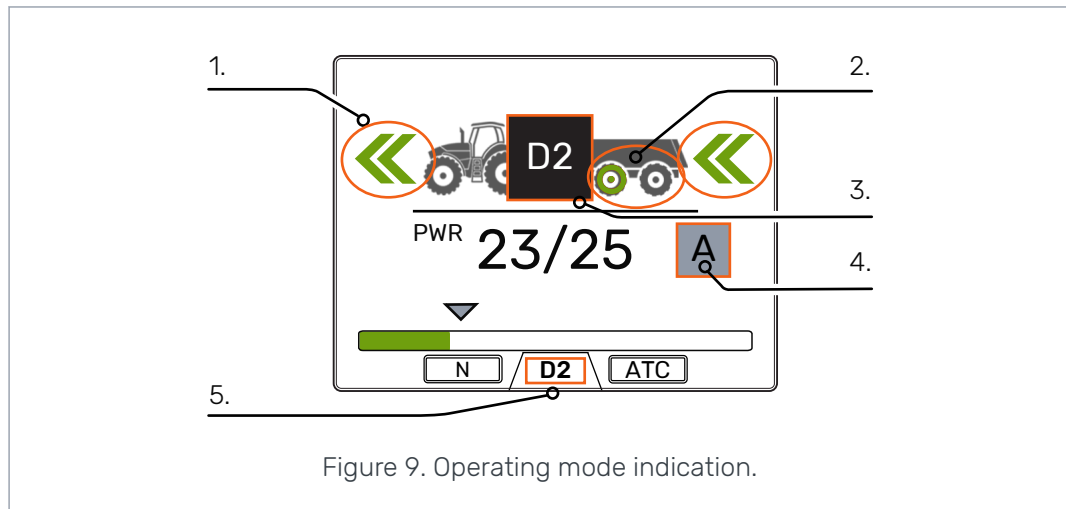









Figure 9. Operating mode indication.

<p><b>1 Arrows</b></p> <p>Show the operation and operating modes as follows:</p> <ul style="list-style-type: none"> <li>• <i>No arrows</i>: Freewheeling</li> <li>• <i>Green arrows</i>: <ul style="list-style-type: none"> <li>• Drive is active to the direction of the arrows.</li> <li>• The double arrows show, if the D2 gear is on.</li> </ul> </li> <li>• <i>Grey arrows</i>: <ul style="list-style-type: none"> <li>• Come into view only in the automatic drive-control mode when the OFF state is active.</li> <li>• Show the working speed range (gear) that is correct for the driving speed. The system uses this gear when you enable the automatic drive-control mode again (you exit the OFF state).</li> </ul> </li> <li>• <i>Intermittent arrows green / grey</i>: <ul style="list-style-type: none"> <li>• During braking</li> <li>• After braking before the tractive power comes back on. Only in the manual drive-control mode.</li> <li>• When the arrows point to the opposite directions &lt; &gt;, the motion detection is enabled for automatic drive activation. Only in the automatic drive-control mode.</li> </ul> </li> </ul>	<p><b>2 Color of the trailer wheels</b></p> <p>Show the hub motor operation modes as follows:</p> <ul style="list-style-type: none"> <li>• <i>2WD system</i>: The color of the front wheel icon changes.</li> <li>• <i>4WD system</i>: The colors of the two wheel icons change.</li> <li>• <i>The wheel colors</i>: <ul style="list-style-type: none"> <li>• <i>Grey</i>: Freewheeling</li> <li>• <i>Green</i>: Drive active, driving mode</li> <li>• <i>Red</i>: Drive active, braking active</li> </ul> </li> </ul> <p><i>System without HDC</i>: Tractive power reduced to minimum level</p> <p><i>System with HDC</i>: HDC function active.</p>
--	--

<p>3</p>	<p><b>Operating mode icons</b></p> <p>The icons come into view to show the system mode and the mode changes:</p> <ul style="list-style-type: none"> <li>• <b>N</b> Freewheeling is active in the manual drive-control mode.</li> <li>• <b>OFF</b> Driving functions are disabled in the automatic drive-control mode. The system is continuously in the free-wheeling mode until the functions are enabled from the display.</li> <li>•  Freewheeling in the automatic drive-control mode. Driving speed is above the drive activation speed range.</li> <li>•  Tractor braking is active.</li> </ul>	<ul style="list-style-type: none"> <li>•  (blinking) No movement. Motion detection is active in the automatic drive-control mode.</li> <li>•  Timeout in motion detection. Press brake to activate the motion detection again.</li> <li>• <b>AUX</b> Auxiliary valve control is active.</li> <li>• <b>D1, D2 and R</b> The icons come into view only during the change. The icons stay out of view during the drive.</li> </ul>
<p>4</p>	<p><b>Drive-control mode indication</b></p> <ul style="list-style-type: none"> <li>•  Manual drive-control mode No speed and direction information available from the ISOBUS.</li> <li>•  Manual drive-control mode Speed and direction information available from the ISOBUS.</li> <li>•  Automatic drive-control mode Speed and direction information available from the ISOBUS.</li> </ul>	<p>5</p> <p><b>Current gear</b></p> <ul style="list-style-type: none"> <li>• <b>N</b>: Freewheeling</li> <li>• <b>D1</b>: Drive forward, speed range 1</li> <li>• <b>D2</b>: Drive forward, speed range 2</li> <li>• <b>R</b>: Drive reverse.</li> </ul>

## 6 Operating functions

### 6.1 Drive control modes

The CTR201 control system allows you to use either the automatic or the manual drive-control mode.

#### **Automatic drive-control mode**

The automatic drive-control mode in the CTR201 control system uses the vehicle speed and the driving direction data from the tractor's ISOBUS. In this mode the control system can perform several driving functions automatically. Thus, it is not always necessary for the driver to use the controls on the display.



#### **Manual drive-control mode with ISOBUS**

When the ISOBUS connection is in operation it is also possible to use the manual drive-control mode. You can use the manual drive-control mode if you want to manually activate and release the drive. This can help you in special situations when it is necessary to use the manual driving functions (for example, if the vehicle is stuck). You can enter the manual drive-control mode on the display.

#### **Manual drive-control mode without ISOBUS**

If there is no data available from the ISOBUS, the control system is always in the manual drive-control mode.

Table 1: Functional differences between the drive control modes.

	 <b>Automatic</b>	 <b>Manual with ISOBUS</b>	 <b>Manual without ISOBUS</b>
Drive activation	Automatic <ul style="list-style-type: none"> <li>When the vehicle starts to move</li> <li>When the vehicle speed returns to the working speed range.</li> </ul>	Manual with restrictions <sup>1)</sup>	Manual
Drive direction selection	Automatic	Manual with restrictions <sup>2)</sup>	Manual
Switching between the speed ranges (D1/D2)	Automatic	Manual	Manual
Return to tractive power after braking	Automatic if the tractor moves	Manual	Manual
Switching to free-wheeling	Automatic if <ul style="list-style-type: none"> <li>The speed is high</li> <li>The pressure is low.</li> </ul>	Automatic if <ul style="list-style-type: none"> <li>The pressure is low.</li> </ul>	Automatic if <ul style="list-style-type: none"> <li>The pressure is low.</li> </ul>
Assisting traction control (ATC) modes	<ul style="list-style-type: none"> <li>Automatic, speed controlled</li> <li>Continuous.</li> </ul>	<ul style="list-style-type: none"> <li>Automatic, timer controlled</li> <li>Continuous.</li> </ul>	<ul style="list-style-type: none"> <li>Automatic, timer controlled</li> <li>Continuous.</li> </ul>

## Operating functions

- 1) Drive activation is allowed when the speed is below the maximum set driving speed.
- 2) Drive activation in opposite direction is possible only at low speeds.

### Drive control mode selection

If the data from the ISOBUS is available, you can change between the automatic and the manual drive-control modes. Use the "Manual mode" selection in the system menu to change to the manual drive-control mode.

If the system has no connection to the ISOBUS, the system automatically changes to the manual control mode.

If the connection to the ISOBUS comes back during the use, you can change to the automatic drive-control mode. You can see from the drive control mode icon if the ISOBUS is available.

## 6.2 Tractive power level selection

You can use the arrow buttons to change the power level (*left*, to decrease the level or *right*, to increase the level). Power levels are 0, 25, 50, 75 and 100% of the maximum level. You can set the value in the freewheeling mode and change it during the driving mode.

- Decrease power: <
- Increase power: >

The green bar shows the measured value and the grey arrow above it shows the set value.

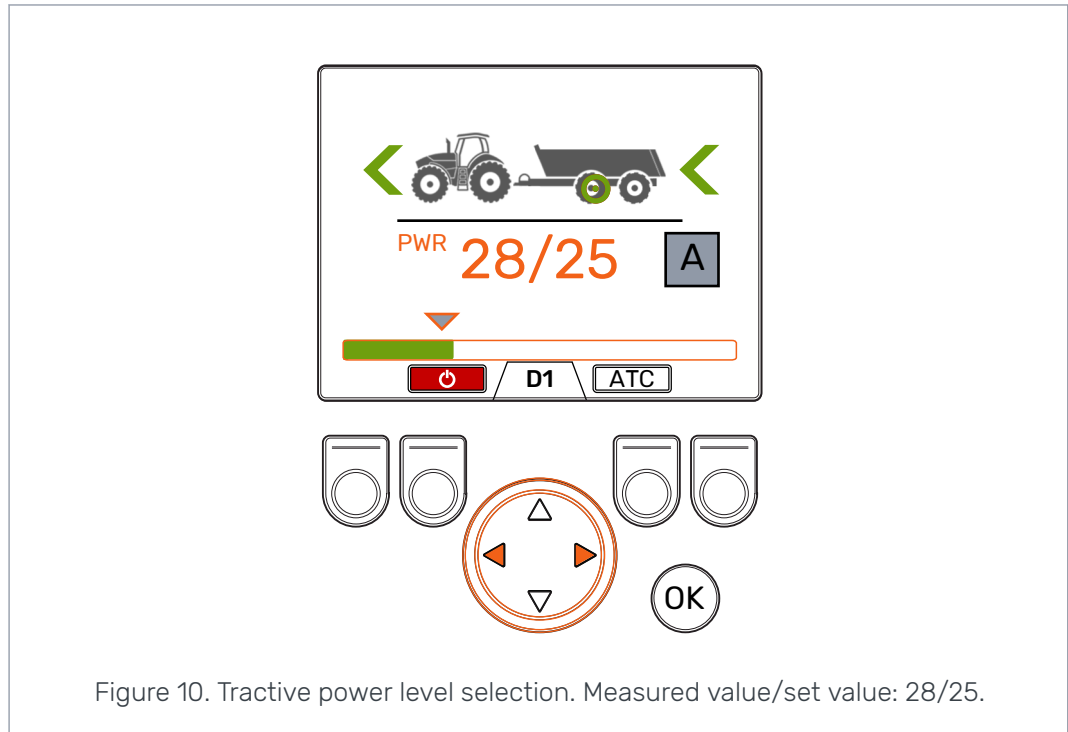

## 6.3

### Driving and freewheeling functions in the automatic drive-control mode

#### A

The driving mode indicator and the direction arrows show the current state of the automatic drive-control mode.

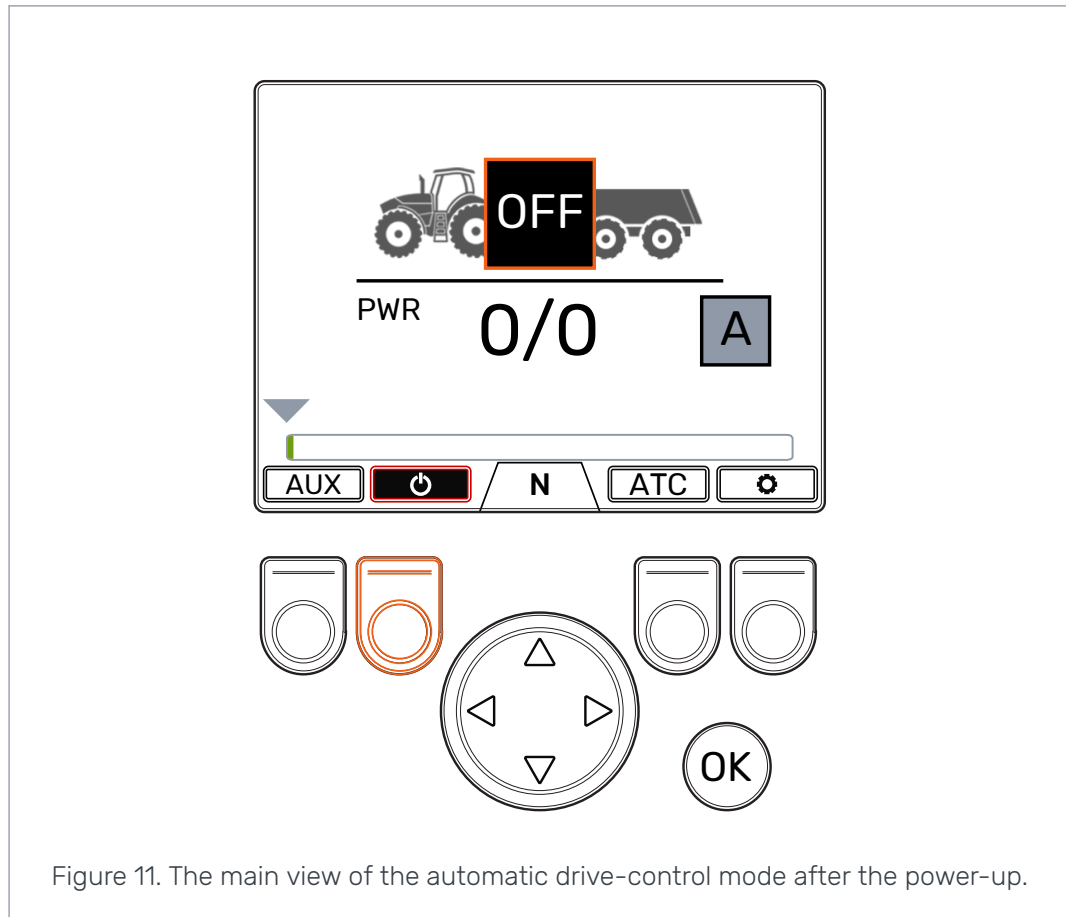

Figure 11. The main view of the automatic drive-control mode after the power-up.

Push the *F2* button to toggle the automatic driving functions **ON** and **OFF**. When the background color of the power icon is red the driving functions are enabled. When the background color of the power icon is black and the driving mode indicator shows **OFF**, the driving functions are disabled.

In the **OFF** state the motors are permanently in the freewheeling mode. Thus, the vehicle speed or direction changes do not have an effect on the mode.

The system **immediately** switches to the driving mode in the direction of travel when you toggle the automatic driving functions **ON** and the vehicle moves at the working speed.

The automatic drive-control mode can activate the drive when it detects that the tractor moves.

The automatic drive activation is available during the motion detection cycle.

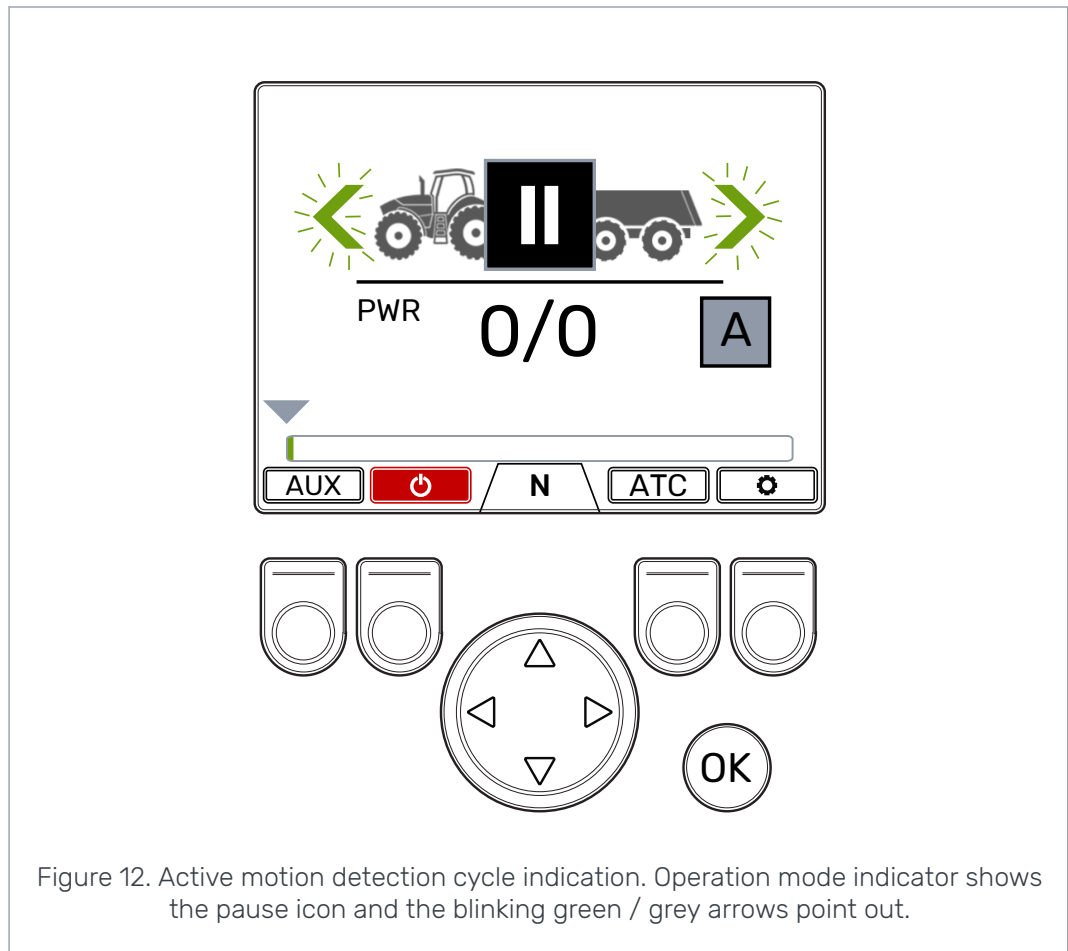

Figure 12. Active motion detection cycle indication. Operation mode indicator shows the pause icon and the blinking green / grey arrows point out.

If the tractor does not move during the motion detection cycle, the system enters the timeout state. In the timeout state the automatic activation of the drive is not in operation. The motion detection cycle activates again when you press the brake pedal. If the tractor moves during this cycle, the drive activates to the driving direction. The tractive power is always at the minimum level when the brake pedal is pressed or when the tractor wheels do not move.

The motion detection cycle is five seconds long and it activates again when:

- You release the brake pedal
- The vehicle stops in the driving mode
- You toggle the driving functions on (you push the *F2* button in the **OFF** state)
- You change the drive control mode from manual to automatic.



**Attention:**

Always change the automatic drive control mode to **OFF** state or change the control mode to manual when you operate the vehicle at idle.

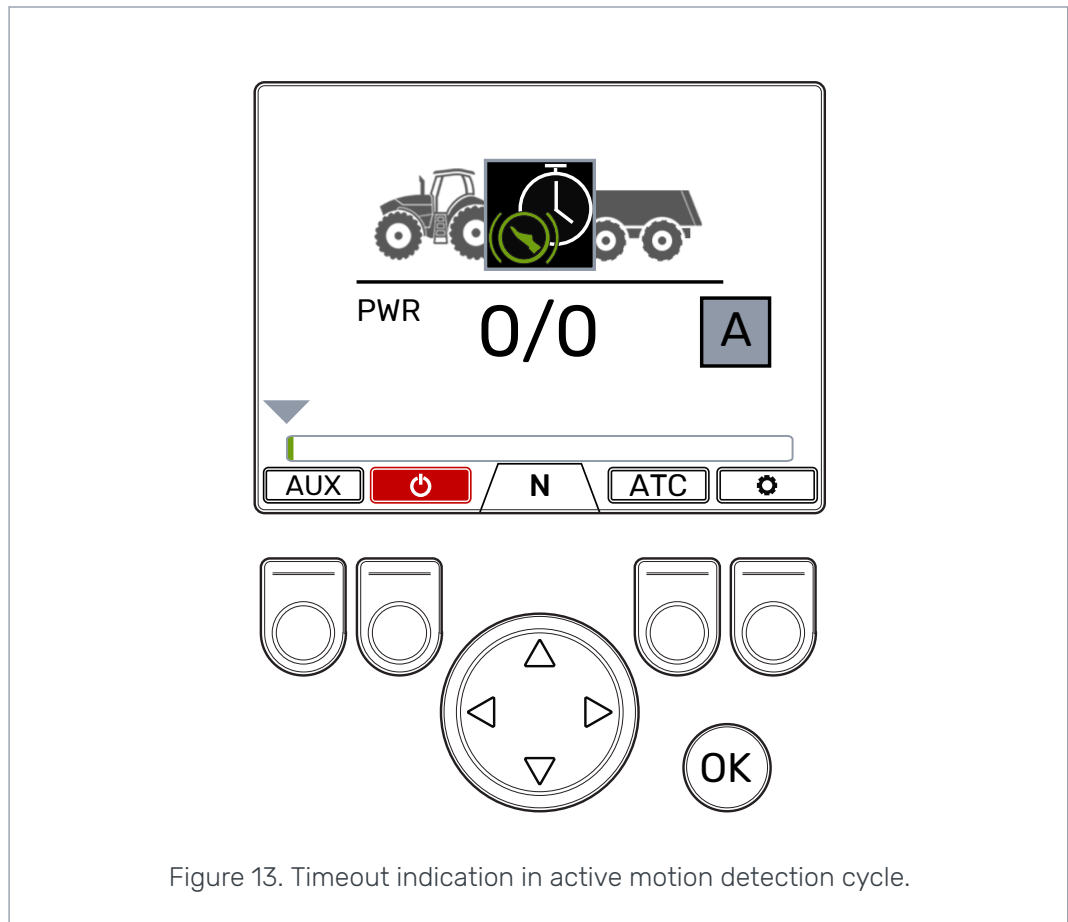

Figure 13. Timeout indication in active motion detection cycle.

The control system switches between the D1 and D2 speed ranges based on the vehicle speed. When the vehicle speed increases above the maximum speed limit, the system switches the motors to freewheeling. When the speed is above the maximum activation speed, the speedometer icon comes into view. The drive activates again when the speed is back in the working speed range. See chapter [User parameters](#) on page 32 for the automatic freewheeling conditions and how to set the related parameters.

## 6.4 Driving and freewheeling functions in the manual drive-control mode



The gear indicator at the bottom of the screen shows the current mode of the drive system.

Use the *up/down* arrows and the *F2* button to change between the freewheeling (N) and the driving modes (D1, D2 and R).



**Note:**

If the ISOBUS connection is not in operation, do not activate the drive if the driving speed is above the working speed range. If the ISOBUS connection is in operation, the system prevents this automatically.

If you drive forward, you can change directly from freewheeling to D2 speed range.



**Note:**



If the ISOBUS connection is not in operation, do not activate the drive to the opposite direction when the tractor moves fast. If the ISOBUS connection is in operation, the system prevents this automatically.

When the tractor moves very slowly, it is possible to activate the drive to the opposite direction.



**Note:**

Do not use the driving modes in road traffic.

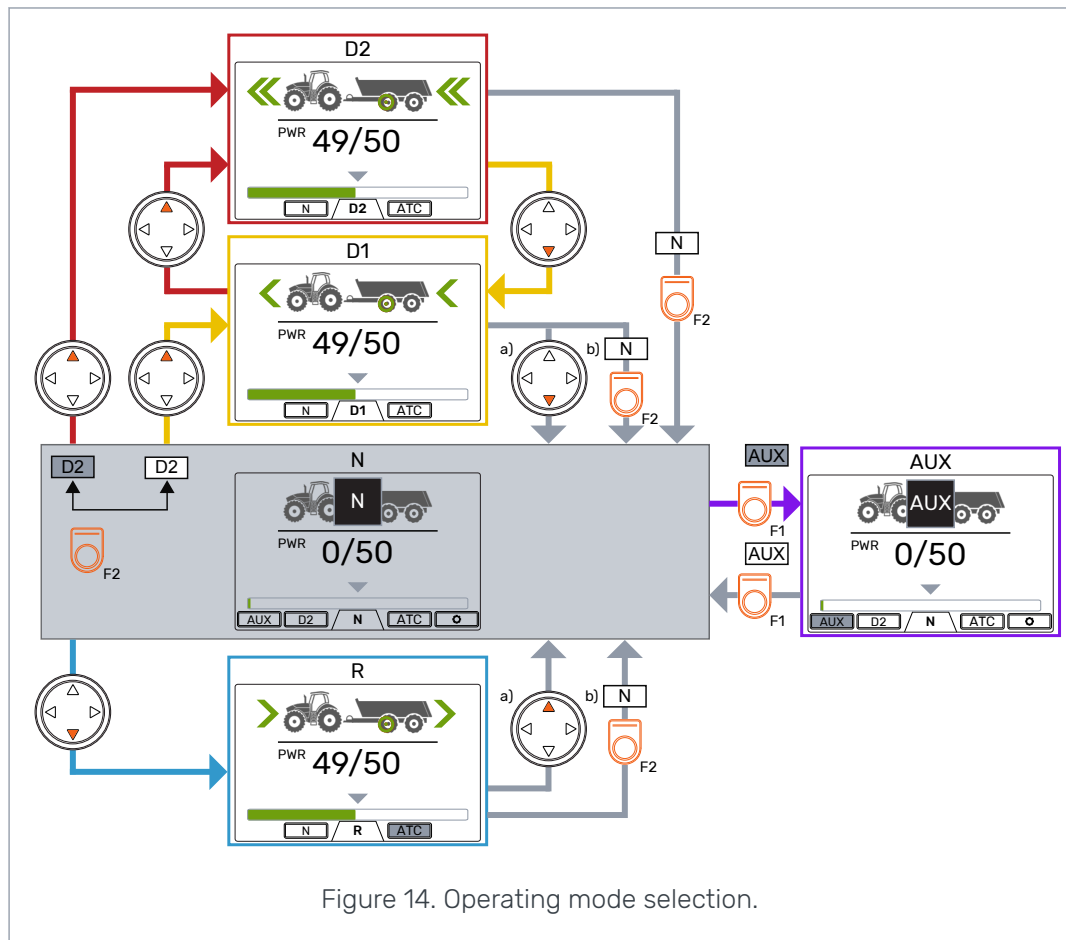

Figure 14. Operating mode selection.

**Automatic freewheeling (N)**

If the pressure level is not sufficient due to increased driving speed, the system automatically switches to the freewheeling mode.

The parameter table (see chapter *User parameters* on page 32) gives the parameters that have an effect on the automatic freewheeling function.

The status bar at the top of the main view shows the warning *Pressure\_low* when the system automatically switches to freewheeling.



Push the *OK* button to remove the warning. The warning also goes out of view when the drive is activated again.

## 6.5 Braking in driving mode

### The system without the HDC function

When the tractor brakes the tractive power reduces to the lowest level. The brake icon comes into view and the trailer wheel color changes to red. The direction arrows blink to show the reduced power level.

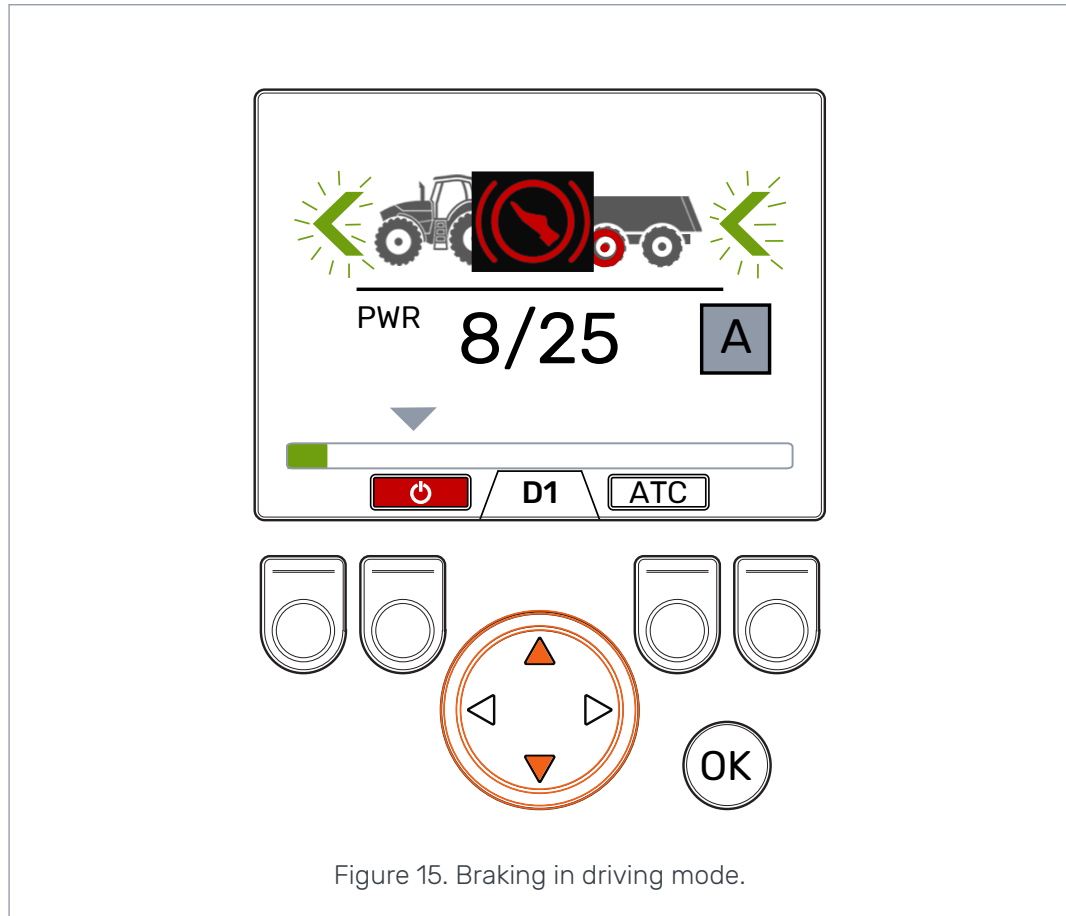

Figure 15. Braking in driving mode.

#### **A** *Operation in the automatic drive-control mode*

After the braking, the tractive power returns to the set level unless the tractor has come to a full stop. In case of a full stop, the system cuts the tractive power to the minimum level and starts the motion detection cycle.

#### **M** **M** *Operation in the manual drive-control mode*

After the braking, the tractive power level stays at the minimum level. To return the tractive power to the selected level:

- If the tractor moves forward, push the arrow button up
- If the tractor moves rearward, push the arrow button down.

### The system with the HDC function (Hill descent control)

If the driving mode is either forward or reverse, the HDC function activates when the tractor brakes. The HDC text comes into view and the power bar color changes to red.

When the HDC function operates the values shown on the display represent the intensity of the HDC function instead of the tractive power. During braking you can adjust the level with the left and right arrow buttons. There are four intensity presets and you can select their levels in the parameter menu.

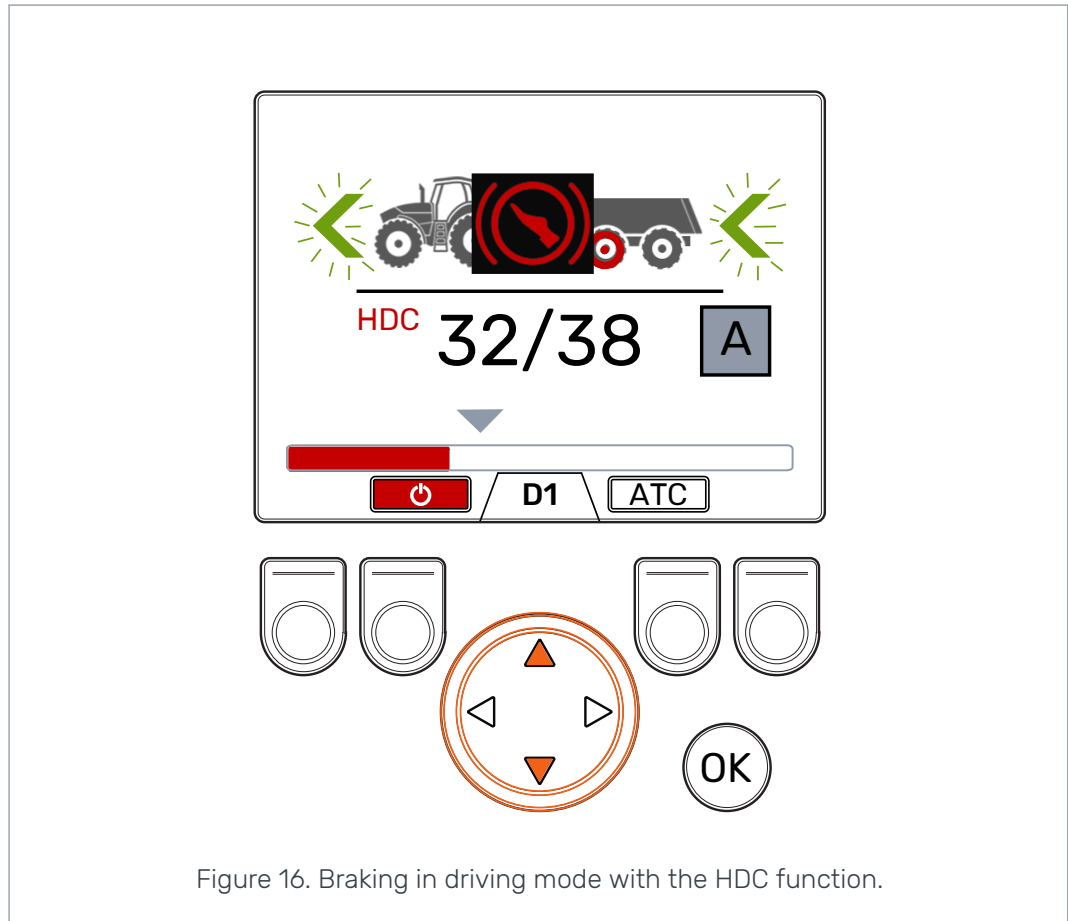

Figure 16. Braking in driving mode with the HDC function.

You can use the HDC during all driving speeds. If the flow to the motors is not sufficient for the driving speed, the vehicle loses the deceleration power. If the speed is too high during the HDC function, the system shows the warning *Overspeed*.



**Note:**



Continuous use of the HDC function can cause the hydraulic fluid temperature to increase.

It is important to monitor the fluid temperature during use.



*Operation in the automatic drive-control mode*

The system changes the speed range automatically during the HDC use. The deceleration is stronger in the D1 speed range. The HDC function stops after the braking. After the braking, the tractive power returns to the set level unless the tractor has come to a full stop. In case of a full stop, the system cuts the tractive power to the minimum level and starts the motion detection cycle.

  *Operation in the manual drive-control mode*

You can also change the speed range during the HDC use. If the speed is low, the D1 speed range makes the deceleration stronger. The HDC function stops after the braking. To return the tractive power to the selected level:

- If the tractor moves forward, push the arrow button up
- If the tractor moves rearward, push the arrow button down.

## 6.6 Assisting traction control (ATC)

The assisting traction control (ATC) helps the tractor to move in difficult conditions.

The ATC function restricts the flow to the wheels that do not have enough traction. This increases the torque on the wheels that have more traction.



**Note:**

The use of the ATC functions for long periods when the wheels have no traction can cause the hydraulic fluid temperature to increase.



**Note:**

You can control the ATC only for the forward drive from the system display. The mode that shows on the display does not have an effect when the tractor moves rearward. The ATC is always continuously on when the tractor moves rearward.



**Note:**

ATC gives more traction to the wheels but it does not fully prevent the wheels from slipping. Thus, it is normal that some of the wheels do slip during the ATC use.



**Note:**

If the wheels slip a lot, the measured power levels that you see on the display are not necessarily correct.



**Note:**

If the flow is not sufficient due to, for example, low tractor-pump rotation speed, the ATC does not operate correctly. To make sure that the ATC can operate correctly, the tractor's pump (engine) speed must be sufficient.



**Note:**

Use the ATC when you drive on difficult terrain and on soft grounds.

 *Operation in the automatic drive-control mode*

The assisting traction control (ATC) function is automatically enabled when the flow is sufficiently low. The ATC function operates without a visual indication on the display.

You can also push the *F3* button to start the continuous operation of the ATC in the automatic drive-control mode.

**ATC** The ATC function is in the automatic operation mode when the background color of the function icon is black.

## Operating functions

**ATC** The ATC function is in the continuous operation mode when the background color of the icon is grey.

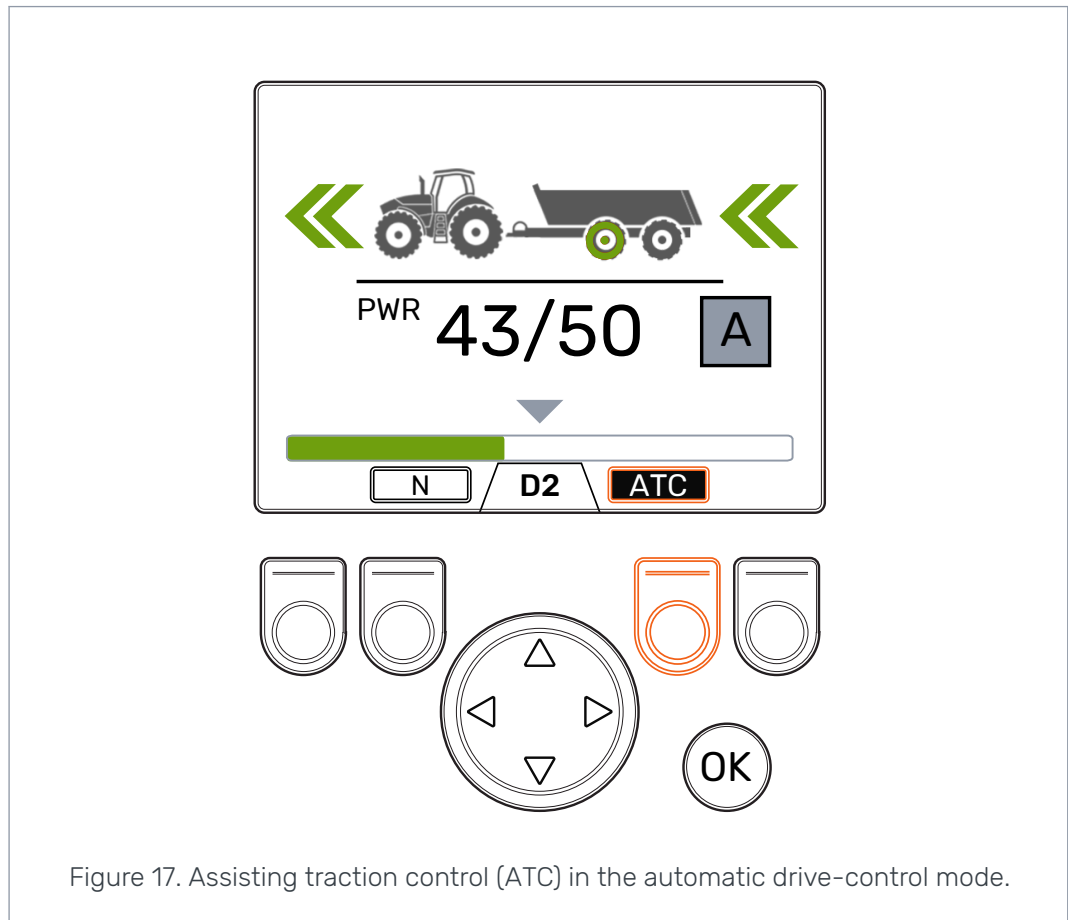

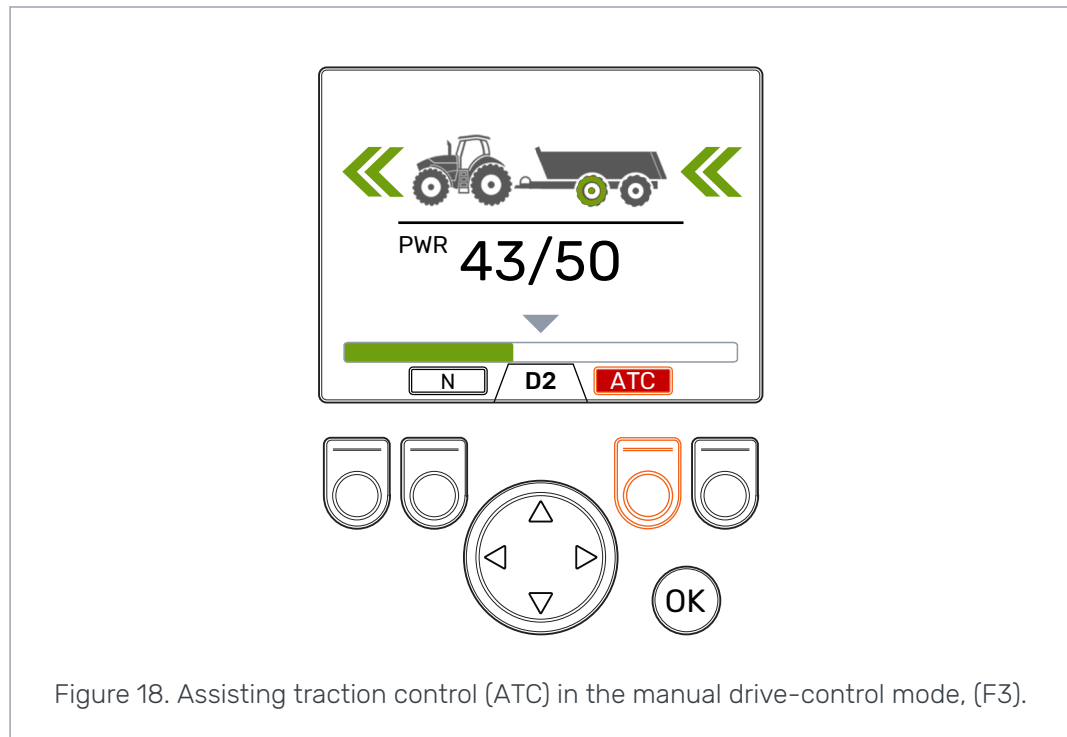

Figure 17. Assisting traction control (ATC) in the automatic drive-control mode.

  *Operation in the manual drive-control mode*

Push the *F3* button to enable and disable the assisting traction control (ATC). The ATC selection is available in all operating modes. The *ATC* icon above the *F3* button is grey when the assisting traction control is enabled.



The value of the parameter *ATC max. time [s]* has an effect on how the ATC function operates:

- Value = 0: The ATC is on continuously during the drive.
- Value > 0: The automatic switch-off delay is in operation. The ATC is continuously on for the set time every time you activate the forward driving mode. When the ATC times out, the background color of the ATC icon becomes red. Push the *F3* button to switch on the ATC again for the set time. When the system switches to freewheeling the switch-off delay resets. When you activate the forward driving mode again, the ATC is on.

## 6.7 Auxiliary valve control (AUX), (F1) (option)

Push the *F1* button to toggle the auxiliary valve on and off.

You can activate the AUX valve when the system is in the freewheeling (N) mode. The driving modes are not available while the AUX valve is activated.

Auxiliary valve function is application specific. For example, a timber trailer can have a selector valve for the loader.

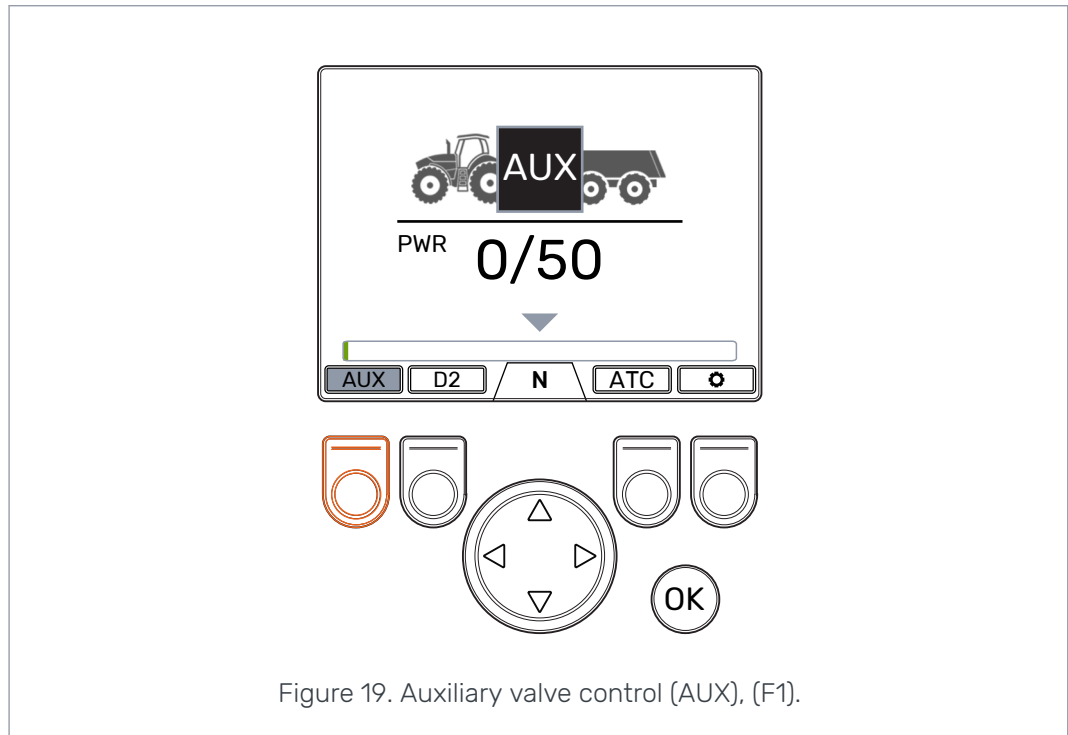

## 6.8 Keypad lock

You can lock the display keypad to prevent accidental operation of the system:

- To lock the keypad, push and hold the *OK* button for 2 seconds.
- To unlock the keypad, push and hold the *OK* button for 2 seconds.



**Note:**

You can lock the keypad only during freewheeling.

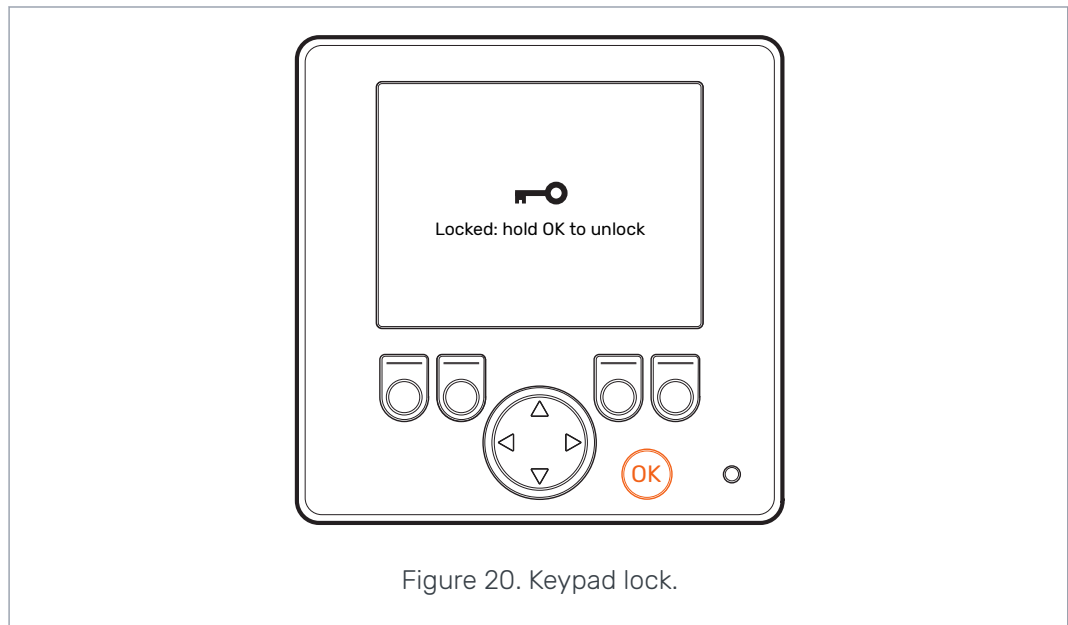



**Danger:**

Make sure that you lock the keypad when you drive on road.

## 7 Setup

### 7.1 User parameters

Adjust the listed parameters before you use the system for the first time.

Parameter	Description	Possible values
<b>2-speed function</b>	Shows if the 2-speed function is available to use (speed range selection D1/D2).	<p>0 / 1</p> <p>0: No 2-speed function. Speed range D1 in operation during forward drive. <u>1-speed motors are connected to the system.</u></p> <p>1: 2-speed function in operation. Speed ranges D1 and D2 in operation during forward drive. <u>2-speed motors are connected to the system.</u></p>
ATC max. time [s]	Sets the automatic switch-off delay for the ATC function.	<p>0 – 120</p> <p>0: No automatic switch-off. The system does not deactivate the ATC automatically.</p> <p>1 – 120: ATC automatic switch-off delay in seconds. See chapter <a href="#">Assisting traction control (ATC)</a> on page 27 for the description of ATC use.</p>
<b>Minimum pressure level [bar]</b>	<p>If the working pressure decreases below the adjusted value, the driving mode automatically switches to freewheeling.</p> <p> <b>Note:</b> <i>Minimum pressure delay [ms]</i> and <i>Disengagement speed [km/h]</i> do also have an effect on the automatic freewheeling.</p>	<p>10 – 30 bar: Minimum pressure value [bar].</p> <p>Too low pressure value can cause rattling sound before the automatic freewheeling activates.</p> <p>Too high pressure value can cause the automatic freewheeling to activate too quickly. It can also cause problems when you activate the driving mode.</p>
<b>Minimum pressure delay [ms]</b>	<p>Time delay that has an effect on the sensitivity of the automatic freewheeling when the working pressure decreases.</p> <p> <b>Note:</b> <i>Minimum pressure level [bar]</i> and <i>Disengagement speed [km/h]</i> do also have an effect on the automatic freewheeling.</p>	<p>1 – 1000 ms: Reaction time to the pressure decrease [ms].</p> <p>Too short time can cause the system accidentally switch to freewheeling during fast moves.</p> <p>Too long time can cause rattling sound from the motors during fast acceleration before the automatic freewheeling.</p>



Parameter	Description	Possible values
Power change ramp	Ramp time that has an effect on the power level adjustment from the display.	<p><i>0 – 4</i></p> <p><i>0</i>: The shortest time – fastest power level change.</p> <p><i>4</i>: The longest time – the smoothest power level change.</p> <p>If it is necessary to change the power level quickly during the drive, reduce the value.</p> <p>If the power level changes too quickly during the drive, increase the value.</p>
<b>Maximum pressure level [bar]</b>	<p>Maximum system pressure level you can adjust.</p> <p>The 100% power level you see on the display equals to the maximum pressure level of the system.</p>	<p><i>0 – 320 bar</i></p> <p>Adjust the value to the available pressure level.</p> <p>Make sure that the allowed operating pressures of other components are in this range (hydraulic motors, pump, hoses, etc.).</p> <p>If the value is low, the pressure level and the tractive power do not increase.</p> <p>If the value is too high, the system cannot get to the highest power level.</p>
Drive activation ramp	<p>Pressure level adjustment ramp time.</p> <p>It has an effect on the power level increase when you activate the drive.</p>	<p><i>0 – 4</i></p> <p><i>0</i>: The shortest ramp time – sharp drive activation.</p> <p><i>4</i>: The longest ramp time – smooth drive activation.</p> <p>You can change the value to smoothen or sharpen the drive activation.</p>
Shifting ramp	Shifting ramp time has an effect on the rate of the speed range change and the sharpness of the change.	<p><i>0 – 4</i></p> <p><i>0</i>: The shortest ramp time – sharp change of the speed range.</p> <p><i>4</i>: The longest ramp time – smooth change of the speed range.</p> <p>You can change the value to smoothen or sharpen the speed range change.</p>

Parameter	Description	Possible values
<b>Disengagement speed [km/h]</b>	<p>Sets the maximum speed for the driving in the automatic drive-control mode. If the speed reaches this value, the control system automatically switches the motors to the freewheeling mode.</p> <p>If 2-speed motors are in operation, the set value is for forward driving in the D2 speed range. The system automatically calculates a lower maximum speed value for the reverse driving.</p> <p>System can also switch to freewheeling if the pressure decreases below the set pressure level (see <i>Minimum pressure level [bar]</i> and <i>Minimum pressure delay [ms]</i>).</p>	<p>1 – 30 km/h</p> <p>The flow capacity and the displacement of the motors have an effect on the applicable value. See chapter <a href="#">Setting the values for the automatic freewheeling</a> on page 36 that tells you how to set the automatic freewheeling parameters.</p>
Motion delay, stop	<p>Sets the delay for the automatic disengagement when the vehicle has stopped. During the delay the drive stays switched on but the tractive power is at the minimum level.</p> <p>When the vehicle moves extremely slowly the delay can prevent not necessary disengagement of the drive.</p>	<p>0 – 4</p> <p>0: The shortest delay. 4: The longest delay.</p> <p>Initially, use the value 4.</p> <p>Use a smaller value if the delayed disengagement causes inconvenience in the driving direction changes.</p>
Motion delay, start	<p>Sets the sensitivity of the motion detection for the automatic drive-activation function.</p>	<p>0 – 4</p> <p>0: The shortest delay – the drive activates quickly when the movements are small.</p> <p>4: The longest delay – the drive does not activate if the movements are slow and short-term.</p> <p>Initially, use the value 2.</p> <p>Decrease the value if the system must react more quickly to small movements.</p> <p>Increase the value if the system is too sensitive and reacts too quickly.</p>

**Parameters for the HDC function (Hill descent control)**

Parameter	Description	Possible values
HDC enabled	The parameter enables and disables the HDC function.	0 / 1 0: HDC function not in operation. 1: HDC function in operation.
HDC level 1, pressure [bar]	HDC power control setting, level 1 (weakest slowing power).	The minimum permitted value is 1. The maximum permitted value is 100 or the value of the parameter <i>Maximum pressure level [bar]</i> .
HDC level 2, pressure [bar]	HDC power control setting, level 2.	The minimum permitted value is the value of level 1. The maximum permitted value is 150 or the value of the parameter <i>Maximum pressure level [bar]</i> .
HDC level 3, pressure [bar]	HDC power control setting, level 3.	The minimum permitted value is the value of level 2. The maximum permitted value is 200 or the value of the parameter <i>Maximum pressure level [bar]</i> .
HDC level 4, pressure [bar]	HDC power control setting, level 4 (strongest slowing power).	The minimum permitted value is the value of level 3. The maximum permitted value is 320 or the value of the parameter <i>Maximum pressure level [bar]</i> .
HDC, activation level	The value sets the power level at the start of the HDC activation.	1 – 3 The level for the start of the HDC activation can be level 1, 2 or 3.
HDC, ramp	Ramp time that has an effect during the HDC level change.  The setting has an effect at the start of the HDC activation and when you change the HDC power setting.	0 – 4 0: The shortest ramp time – the sharpest operation. 4: The longest ramp time – the smoothest operation.  If the HDC function operates too fast at the start of the activation and when you change the power level, use larger value.

**7.2****Automatic freewheeling conditions**

The CTR201 control system can use the tractor speed information and the measured pressure level to automatically switch to freewheeling.

The parameter for the **speed condition** is the *Disengagement speed [km/h]*. In the automatic drive-control mode the system switches to freewheeling when the driving speed increases to the set value. If the 2-speed motors are in operation, the set value

is for forward driving in the D2 speed range. The system automatically calculates a lower maximum speed value for the reverse driving.

The *Disengagement speed [km/h]* parameter also has an effect on the automatic speed range shift and the automatic drive activation functions. Thus, it is important to set the parameter correctly.

In the manual drive-control mode the *Disengagement speed [km/h]* parameter:

- Does also have an effect on the maximum allowed drive activation speed if the ISOBUS speed information is available.
- Does not have an effect if no speed information is available.

The parameters for the **low pressure condition** are the *Minimum pressure level [bar]* and the *Minimum pressure delay [ms]*. In the driving mode, the system switches to freewheeling when the pressure level stays below the set *level* parameter value for the time set in the *delay* parameter.

### 7.3 Setting the values for the automatic freewheeling

First set the parameters for the low pressure condition of the freewheeling as follows:

1. Change the control system to the manual drive-control mode.
2. Set the power level to 0 %.
3. Stop the vehicle.
4. Activate the drive forward.
5. If the warning *Pressure\_low* shows, decrease the value of the *Minimum pressure [bar]* parameter.
6. Activate the drive again.
7. Examine the percentage of the measured power that shows on the display when the vehicle does not move.
8. Calculate the actual stand-by pressure as follows:

$$\text{Stand-by pressure} = \text{MaxPressure} \times \text{MeasPower} / 100$$

Where,

- The MaxPressure is the *Maximum pressure level [bar]* parameter in the parameter menu.
- The MeasPower is the measured power level percentage that shows on the display.

The *Minimum pressure level [bar]* value must usually be 5 – 10 bars smaller than the stand-by pressure.

9. Do the test for the freewheeling conditions as follows:
  - a. Activate the drive forward.
  - b. Increase the speed until the system switches to the freewheeling mode and the warning *Pressure\_low* shows.

If the hydraulic motors make a rattling sound **before** the automatic freewheeling activates, try one of the adjustments that follow:

- Increase the *Minimum pressure level [bar]* parameter value.
- Decrease the *Minimum pressure delay [ms]* parameter value.

If the automatic freewheeling is too sensitive, try one of the adjustments that follow:

- Increase the *Minimum pressure delay [ms]* parameter value.
- Decrease the *Minimum pressure level [bar]* parameter value.

When you have set the automatic freewheeling correctly in the manual drive-control mode, you can set the automatic freewheeling for the automatic drive-control mode.

The primary condition for the freewheeling in the automatic drive-control mode is the parameter *Disengagement speed [km/h]*. The low pressure condition is for the manual drive-control mode. But if the hydraulic pump speed reduces in the automatic drive-control mode, the low pressure condition must also activate the freewheeling.

10. In the manual drive-control mode, activate the drive forward in D2 speed range.
11. Slowly increase the speed while you monitor the tractor speed.
12. Record the speed when the warning *Pressure\_low* shows and the freewheeling activates.
13. Set the *Disengagement speed [km/h]* parameter to a value that is 2 – 3 units smaller than the tractor speed before the low pressure condition.
14. Change to the automatic drive-control mode.
15. Drive forward while you use the automatic driving functions.
16. Increase the driving speed until the freewheeling activates.

If the high speed causes the automatic freewheeling, the operating mode indicator on the display shows a speedometer icon. You can repeat the test with an increased speed parameter value to find if the use of a higher speed value is possible.

If the low pressure condition causes the automatic freewheeling, decrease the speed parameter value, and repeat the test. Make sure that you decrease the speed parameter value to a point where the speed condition reacts before the low pressure condition. Use this speed parameter value.

## 8 Troubleshooting

The status bar at the top of the main view shows all alarms and warnings. The table that follows gives the causes of the alarms and warnings, and procedures to correct them.

Table 2: Fault messages.

Alarm/warning message	Cause	Procedures
1: Coil_fail-ure_PDB	Error in the control of the valve solenoid PDB.	<p>Make sure that the valve cable connects correctly to the connector in the control device and to the valve solenoid.</p> <p>Make sure that the cable is not damaged.</p> <p>Measure the solenoid resistance:</p> <ol style="list-style-type: none"> <li>1. Remove the cable from the valve solenoid.</li> <li>2. Measure the resistance with a multimeter from the solenoid connector.</li> <li>3. Compare the value with the value shown on the product card.</li> </ol> <ul style="list-style-type: none"> <li>• If the value is very different from the value on the card, make sure that the cable connects to the correct valve.</li> <li>• If the multimeter does not show the value (the resistance value is infinite), the solenoid is defective. Replace the solenoid.</li> </ul>
2: Coil_fail-ure_WV2	Error in the control of the valve solenoid WV2.	
3: Sensor_fail-ure_pressure_A	The signal from pressure sensor A is defective.	Make sure that the pressure sensor cable connects to the pressure sensor and the cable is not damaged.
4: Sensor_fail-ure_pressure_B	The signal from pressure sensor B is defective.	To test the sensors, change the pressure sensors A and B with each other. If the alarm message changes, the pressure sensor is damaged. Replace the pressure sensor.
5: Pressure_high	The working pressure is more than the maximum system pressure, 350 bar.	<p>Examine the main pressure relief valve (on the pump or as a separate valve). Make sure that it operates and is adjusted correctly.</p> <p>If you use the CVM120 valve, make sure that the DW valve has the correct setting for the pump type. Refer to the product manual.</p>

Alarm/warning message	Cause	Procedures
6: Pressure_low	The working pressure decreases below the specified minimum pressure value during the drive and the system automatically switches to the freewheeling mode.	<p>The driving speed is too high for the drive. Use D2 driving mode for higher speed.</p> <p>If the warning comes on when the tractor does not move or it comes on very easily during the drive, examine the automatic freewheeling parameters <i>Minimum pressure [bar]</i> and <i>Minimum pressure delay [ms]</i>. See chapter <a href="#">User parameters</a> on page 32.</p> <p>If the power bar does not increase at all when you activate the drive, examine the hydraulic connections.</p> <p>Make sure that the valve cables M_A and M_B connect to the correct pressure sensors. Make sure that the pressure sensors connect to the correct measuring points.</p> <p>Make sure that the P_A and P_B valve cables connect to the correct solenoids.</p> <p>The <i>Pressure_low</i> alarm is a warning and does not require an OK button reset.</p>
7: Display_detached	There is no connection between the system display and the control device.	<p>Examine the connection of the display cable.</p> <p>Make sure that the display cable is not damaged.</p> <p><b>When the system display disconnects the system information is erased from the memory. Thus, you must also start the control device again after the alarm.</b></p>
8: SW_version_mismatch	4WD: The software versions of the primary control device and the auxiliary control device are different.	<p>Examine the software versions from the system information view.</p> <p>Replace the device that has the incorrect software version.</p> <p>Make sure that all system components have the same software version.</p>
9: Coil_failure_PA	4WD: Error in the control of the valve solenoid P_A connected to the auxiliary control device.	Do the same checks as with alarms 1 and 2.
10: Coil_failure_PB	4WD: Error in the control of the valve solenoid P_B connected to the auxiliary control device.	
11: Coil_failure_WV3	4WD: Error in the control of the valve solenoid WV3 connected to the auxiliary control device.	

## Troubleshooting

Alarm/warning message	Cause	Procedures
12: CAN_connection_break	4WD: No CAN connection between the primary control device and the auxiliary control device.	Examine the CAN cable between the control devices.
13: Coil_failure_PDB2	HDC: PDB2 valve solenoid control error.	Do the same checks as with alarms 1 and 2.
14: Overspeed	HDC: Low working pressure during the operation of Hill descent control.	<p>The flow to the motors is not sufficient because of the speed. Use the brake to decrease the speed. In forward driving, use the D2 speed range, if available.</p> <p>The <i>Overspeed</i> alarm is a warning. The message goes out of view when the pressure increases to the correct level or when the HDC function stops.</p>
15: ISOBUS_error	The control device cannot read the necessary signals from the tractor's ISOBUS.	Examine the cable from the ISOBUS implement socket of the tractor to the control device of the CTR201. Examine the power state of the tractor.
16: External_alarm	Alarm from an external alarm circuit.	<p>The alarm activates when an external signal connects to the system.</p> <p>The device can be, for example, a temperature -, a pressure - or a reservoir level switch.</p> <p>Examine the switch and the external circuit.</p>

### Other possible faults

Fault	Cause and procedures
You cannot get to the main view from the brake-signal check-dialog view when you press the brake. The main menu does not open.	<p>The control device does not operate correctly:</p> <ul style="list-style-type: none"> <li>Control device is not correctly connected. Make sure that all valve solenoids are connected.</li> <li>Make sure that the control device segment-display operates correctly. See chapter <i>Control device segment-display</i> on page 41.</li> </ul>
<p>The menu or user interface does not have all the necessary texts.</p> <p>The user interface does not have all the necessary functions, for example, speed range change.</p>	<p>Disconnect and connect the display cable.</p> <p>To repair the system functions, power-off the system and power-up the system again.</p>
Drive functions are not correct, for example, driving direction functions operate in the opposite direction.	<p>Examine the valve connections to the control device.</p> <p>Wiring diagrams for different systems are in the On-Demand Drive System product manual.</p>



## 8.1 Display status indicator LED

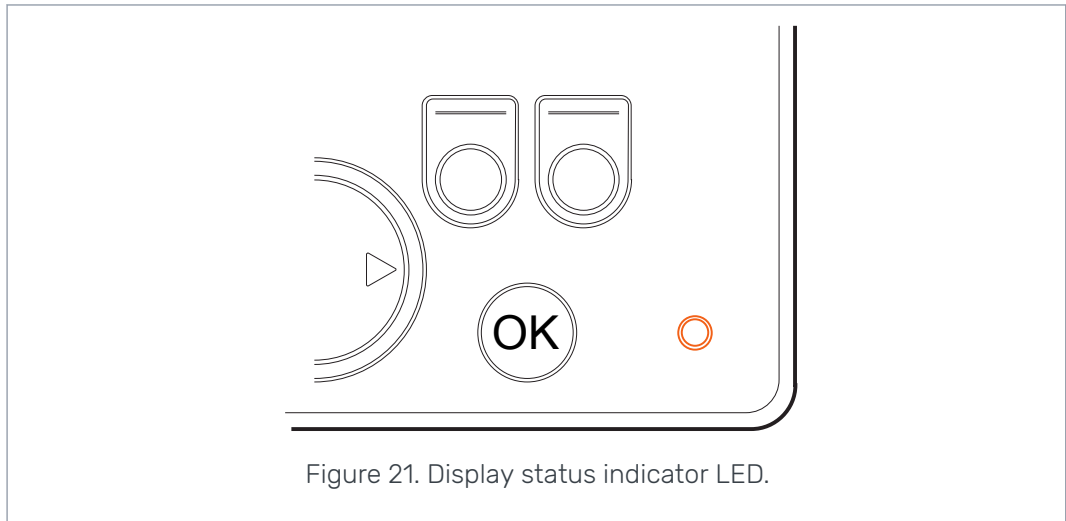

Color/status	Description
No LED	No operating voltage
Orange, 1 flash	Device starts
Green, 5 Hz	The device has no software
<b>Green, 2 Hz</b>	<b>Usual status</b>
Green, continuous	Software error
Red, 5 Hz	Too low operating voltage, software stops
Red, continuous	Dangerous device error

## 8.2 Control device segment-display

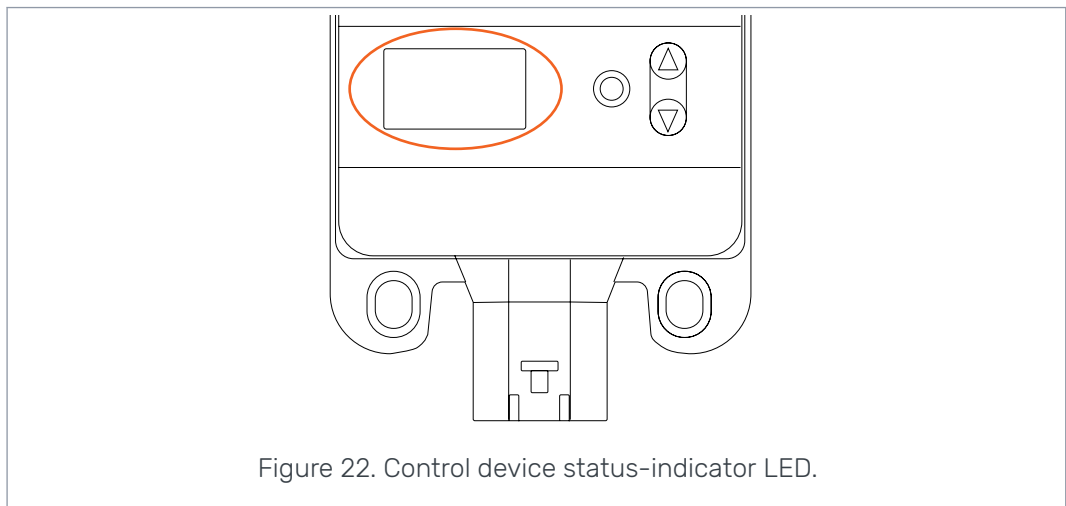

### Status LED

LED/status	Description
No LED	No operating voltage
PWR + DIA, 1 flash	Device starts

LED/status	Description
PWR, 5 Hz	The device has no software
<b>PWR, 2 Hz</b>	<b>Usual status</b>
PWR, continuous	Software error
PWR, 10 Hz	Software error
Red, 5 Hz	Too low operating voltage, software stops
Red, continuous	Dangerous device error

**Segment display text, 2WD-system**

Display text	Description
<b>Empty, no text</b>	<b>Ok</b>
<i>B</i>	The connections to the device are not correct or the connections are defective.  The system is not in operation.

**Segment display text, 4WD-system**

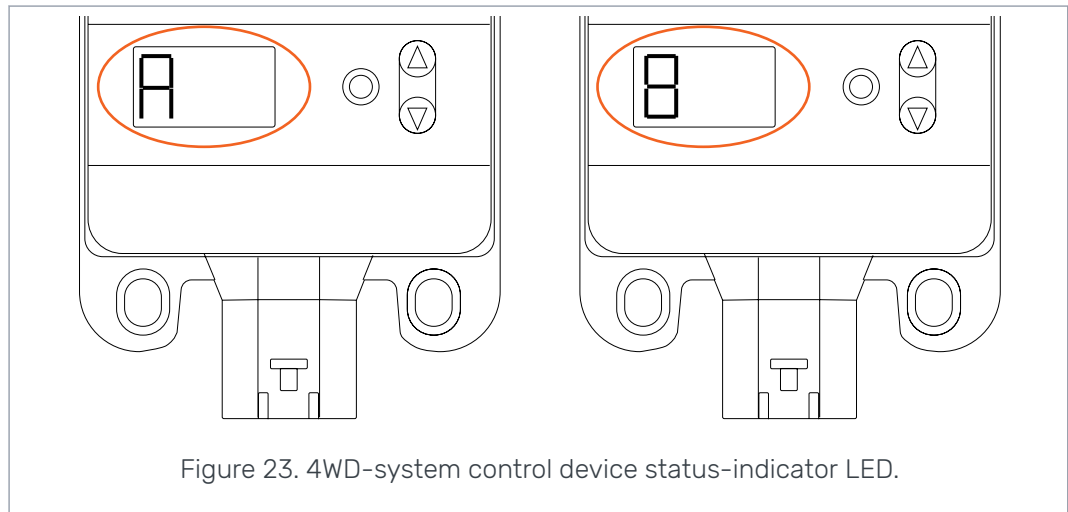

Figure 23. 4WD-system control device status-indicator LED.

Display text	Description
Empty, no text	The system does not recognize the 4WD-auxiliary control device. The system does not operate correctly.
<b>One device "A", the other device "B"</b>	<b>Usual status, 4WD-control device is in operation.</b>
<i>E1 or E2</i>	Defective equipment connections to the control devices.  The system is not in operation.

# No POWER like it.



## **Black Bruin Inc.**

+358 20 755 0755  
P.O. Box 633, FI-40101 JYVÄSKYLÄ, FINLAND

[www.blackbruin.com](http://www.blackbruin.com)  
[info@blackbruin.com](mailto:info@blackbruin.com)

All the information contained in this publication is based on the latest information available at the time of publication. Black Bruin Inc. reserves the right to make changes without prior notice.